

Autolab Application Note COR04

Corrosion Part 4 – Equivalent Circuit Models

Keywords

Corrosion; Electrochemical methods; Electrochemical impedance spectroscopy; Equivalent circuit

Summary

In recent years Electrochemical Impedance Spectroscopy or EIS has been successfully applied to the study of corrosion systems. EIS has been used effectively to measure the polarization resistance for corrosion systems and for the determination of corrosion mechanisms for systems where DC electrochemical methods have failed.

EIS has been applied, among others, to uniform corrosion, pitting corrosion, corrosion in concrete, and corrosion underneath coatings. In this application note some of the equivalent circuit models that are used to model corrosion systems are described.

Uniform corrosion

The most common equivalent circuit used to model corrosion of bare metal in aqueous electrolyte is the Randles circuit, shown in Figure 1. The model can be used to estimate the polarization resistance R_p from the impedance data.

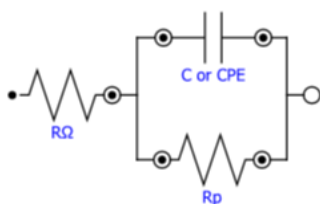

Figure 1 – The typical Randles circuit

Where $R_Ω$ is the uncompensated solution resistance, R_p is the polarization resistance and C or CPE (Constant Phase Element) is the double layer capacitance. Figure 2 shows typical Nyquist plots for a Randles equivalent circuit with a C or CPE element. The CPE element introduces a depression of the semicircle.

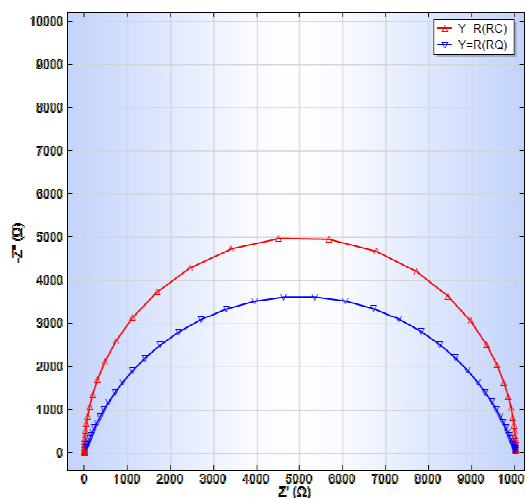

Figure 2 – Typical Nyquist plots for a Randles equivalent circuit with a C or CPE element

For corrosion of low carbon steel in NaCl solution, the equivalent circuit shown in Figure 3 has been proposed.

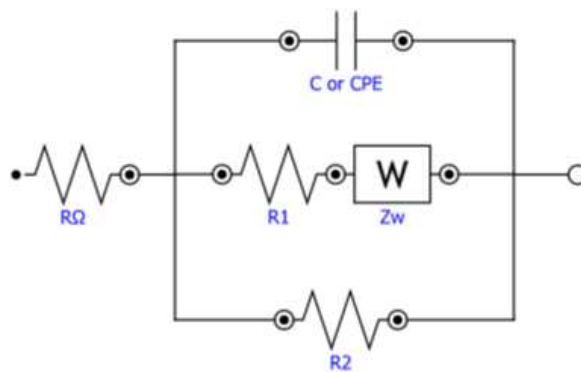

Figure 3 – Circuit 2

Where $R_Ω$ is the uncompensated solution resistance, $R1$ and $R2$ are the charge transfer resistance values of the anodic and cathodic reaction, respectively and C or CPE is the double layer capacitance. ZW is the Warburg impedance used to simulate the mass-transport effects.

Figure 4 shows a typical Nyquist plot corresponding to the proposed circuit shown in Figure 3.

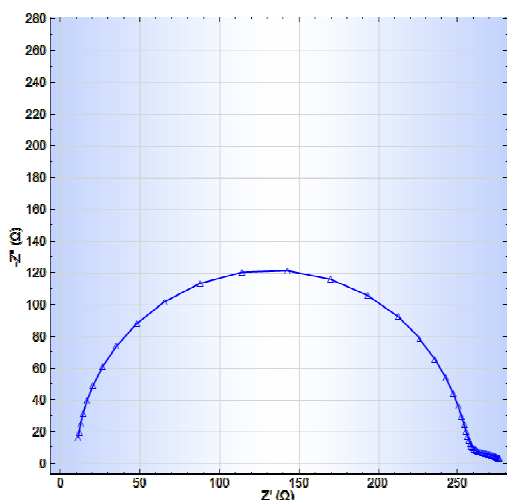

Figure 4 – Typical Nyquist plot corresponding to circuit 2

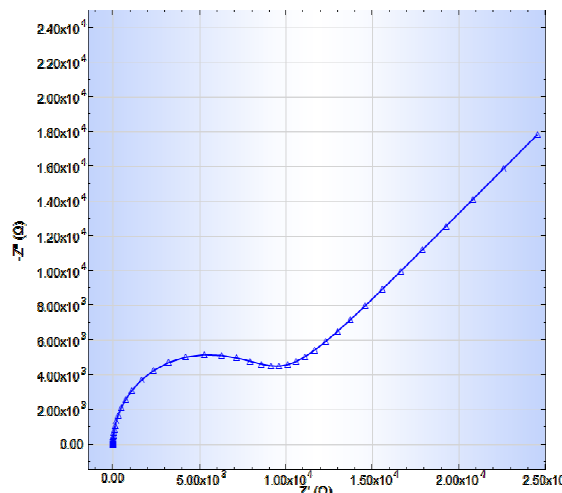

Figure 6 – Typical Nyquist plot corresponding to circuit 3

Coatings

Impedance spectroscopy has been used extensively to characterize the corrosion protection of metals by coatings. The equivalent circuit shown in Figure 5 is often used to model a coating.

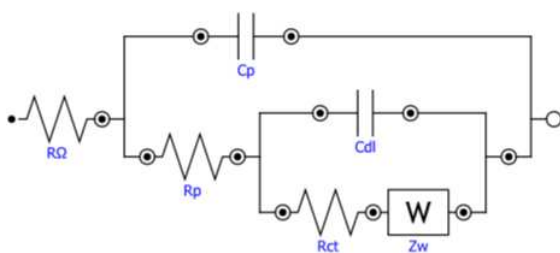

Figure 5 – Circuit 3

Where R_{Ω} is the uncompensated solution resistance, R_p is the paint resistance, which is an indication of the coating's porosity. C_p is the paint capacitance, which quantifies the water uptake by the coating. R_{ct} is the charge transfer resistance, which provides a value of the protection of the substrate. C_{dl} is the double layer capacitance, which can be correlated to the delamination of the coating. Z_w quantifies the mass-transport related contributions.

Figure 6 shows a typical Nyquist plot corresponding to the proposed circuit shown in Figure 5.

When the coating is intact, in the previous circuit, R_p the paint resistance goes to infinity and the circuit reduces to the following equivalent circuit model:

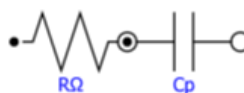

Figure 7 – Circuit 4

Figure 8 shows a typical Nyquist plot corresponding to the proposed circuit shown in Figure 7.

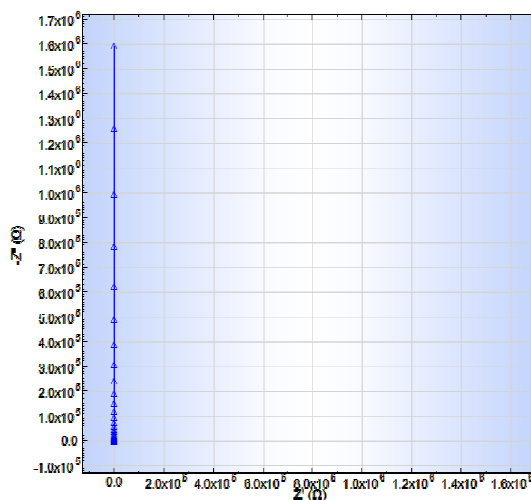

Figure 8 – Typical Nyquist plot corresponding to circuit 4

Corrosion in concrete

The following equivalent circuit has been proposed for the corrosion of steel in concrete.

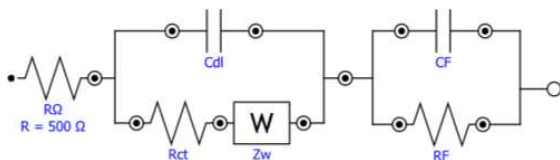

Figure 9 – Circuit 5

Where R_{Ω} is the uncompensated solution resistance, R_F is the resistance at the concrete/stainless steel interface, CF is the concrete/stainless interfacial capacitance, R_{ct} is the charge transfer resistance of the corrosion reaction, C_{dl} is the double layer capacitance and Z_W is the Warburg impedance related to the diffusion of oxygen to steel.

Figure 10 shows a typical Nyquist plot corresponding to the proposed circuit shown in Figure 9.

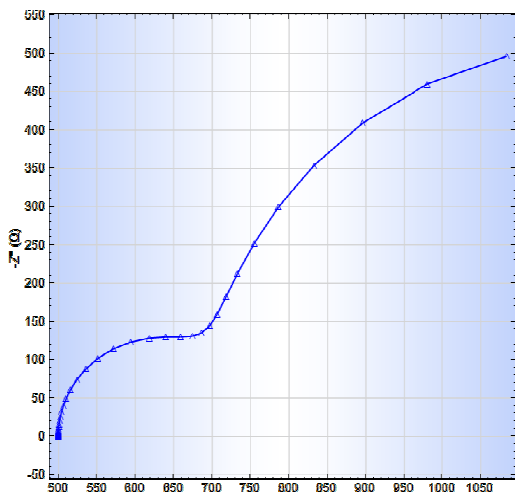

Figure 10 – Typical Nyquist plot corresponding to circuit 5

Date

1 July 2011